

UNIFIX 50



- FR** **Le support universel**
(sol, mur, mât, ...) p.2-10
- EN** **The universal mounting bracket**
(floor, wall, masts) p.11-19
- ES** **El soporte universal**
(suelo, pared, mástil,...) p.20-28
- IT** **Il supporto universale**
(suolo, muro, palo ...) *www.uniteck.fr*

Cher client, nous vous remercions pour votre achat de l'un de nos produits Uniteck. Veuillez lire avec attention toutes les instructions avant d'utiliser le produit.

DESCRIPTION

Les supports Unifix ont été conçus spécialement pour fixer vos panneaux photovoltaïques Unisun **ou équivalents (cf partie panneaux compatibles)**:

- Unifix 50 pour vos panneaux Unisun 50.12M/55.12BC

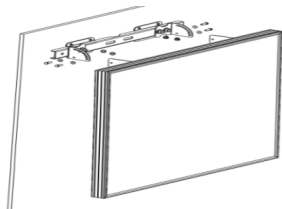

UNIFIX 50

Simple à installer, ils se fixent soit :

- sur une surface plane rigide à l'horizontale ou à la verticale (ex: mur, sol béton, ossature bois).
- sur mât rond d'un diamètre de 40 à 60 mm (bride fournie)
- sur mâts de signalisation utilisant des brides avec visserie M8

Grâce à leur structure en acier galvanisé et leur visserie en inox résistant à la corrosion, ils sont parfaitement adaptés pour un usage en extérieur.

Dotés du système d'inclinaison multi-position, les supports Unifix vous permettent d'optimiser vos performances en fonction de l'orientation choisie.

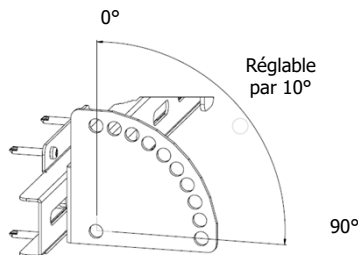

Performance électrique en fonction de l'inclinaison et de l'orientation panneau

	0°	30°	60°	90°
Est	93%	90%	78%	55%
Sud-Est	93%	96%	88%	66%
Sud	93%	100%	91%	68%
Sud Ouest	93%	96%	88%	66%
Ouest	93%	90%	78%	55%

Pour réaliser la connexion panneau/régulateur/batterie, nous vous recommandons d'utiliser le kit prêt à l'emploi Uniconnect 1.6 qui optimise vos performances électriques et simplifie le montage (kit de connexion 1 panneau).

UNIFIX 50

PANNEAUX COMPATIBLES

Grâce à leur design basé sur l'utilisation de perçage Oblong, Unifix permet la fixation de différents panneaux du marché.

Unifix 50 accepte 1 panneau, avec les entraxes et dimensions panneaux comme indiquées ci-dessous.



Système de fixation par oblong

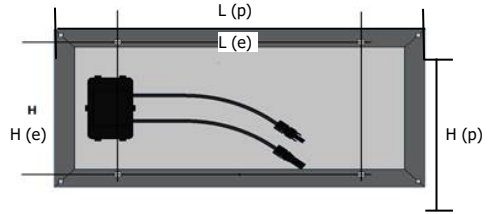

Entraxe et dimensions panneau

	Dim support		Nbre de panneaux			Entraxes pour la fixation de chaque panneau (en mm)		Dimension panneau maxi		Poids Total maxi panneaux (en Kg)
	L	H	x1	x2	x3	L (e)	H (e)	L (p)hh	H (p)	
Unifix 50	550	50	•			80 > 510	180 > 510	pas de maxi	550	6

CONSIGNES DE SÉCURITÉ

- Prenez les mesures appropriées pour prévenir les accidents pendant vos travaux de montage.
- Si le support et le matériel de montage sont exposés aux rayons du soleil pendant une longue période, il y a un risque de brûlure. Protégez-vous.
- A la fin des travaux, vérifiez que vos supports et panneaux soient bien fixés

RECOMMANDATIONS

Montez les supports Unifix uniquement sur des surfaces présentant une portance suffisante. Tenez compte de la charge supplémentaire avec panneau :

Support	Panneau
Unifix 50 = 2,6 kg	Unisun 50.12M / 55.12 BC = 4,1 kg / 3,8 kg

Fixation : pour éviter que de grandes quantités de neige ne s'accumulent derrière le capteur, installez en amont des grilles d'arrêt appropriées.

La disposition des capteurs influence vos performances électriques. Choisissez l'inclinaison et l'orientation la plus optimale en fonction de votre environnement. Evitez les zones d'ombre ou que certains objets ne soient source d'ombre (ex. arbre)

Avant toute fixation et connexion, veuillez respecter :

- Les distances maximums indiquées ci-dessous entre chaque élément.
- L'ordre de raccordement

Câblage Unifix avec kit de connexion Uniconnect 1.6

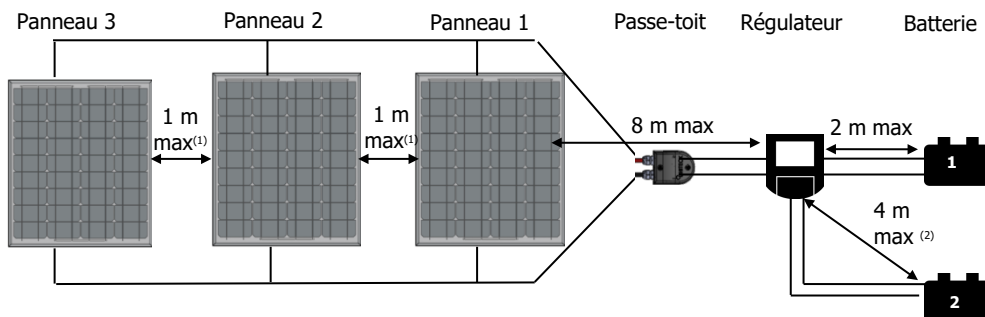

(1) Possibilité de rallonger la distance entre les panneaux d'un mètre supplémentaire, en rajoutant un Unicable 612B et 612 R (câbles non fournis avec le kit Uniconnect 1.6).

(2) Kit connexion batterie, non fourni avec le kit Uniconnect 1.6 (option)

Ordre de connexion

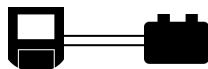

① Connexion régulateur → batterie

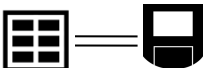

② Connexion panneau → régulateur

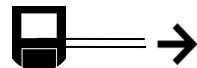







③ Connexion régulateur → consommateur électrique

Pour le débranchement veuillez procéder dans l'ordre inverse. Pour plus d'informations, se référer au manuel d'utilisation de votre régulateur de charge photovoltaïque.

UNIFIX 50 - COMPOSITION

LISTE DES PIECES

						
M8x100 x2	M8X20 X8	M5x16 x4	D8 x 10	D5 x4	M8 x10	M5 x4

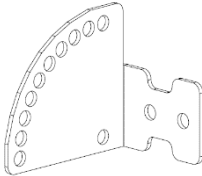
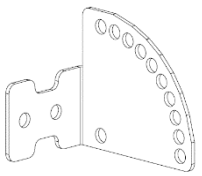
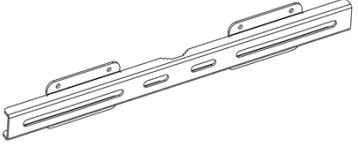
		
n°1 x1	n°2 x1	n°4 x1

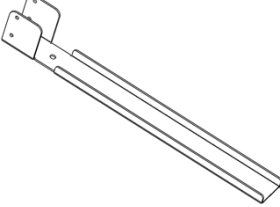
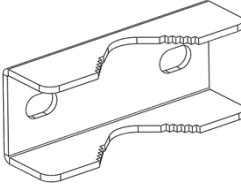
	
n°7 x2	n°13 x1



Couple de serrage préconisé

Vis	Couple
M5	5,10 Nm
M 6	8,80 Nm
M 8	21,50 Nm
M 10	44,00 Nm

Nb. Coefficient de frottement moyen $\mu=0,20$ / Serrage à 50% de la limite élastique



UNIFIX 50 - PRÉPARATION AVANT MONTAGE

- Assemblez les 2 supports N°7 sur votre panneau photovoltaïque Unisun. Pré-serrez les écrous. Le serrage définitif sera réalisé à la fin de l'assemblage.

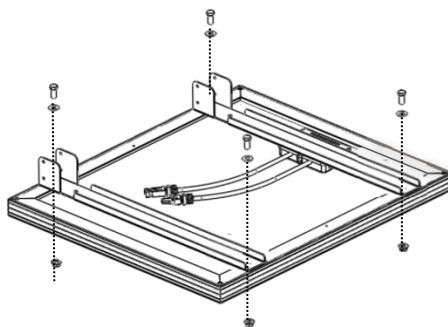
	M8x20 x4
	D8 x4
	M8 x4

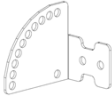
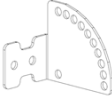
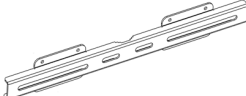

- Fixez les pièces n°1 et 2 sur la pièce n°4. Positionnez les pièces 1 et 2 en fonction de la taille de votre panneau solaire. Pré-serrez les écrous. Le serrage définitif sera réalisé à la fin de l'assemblage.

	M8x20 x4
	D8 x4
	M8 x4
	N°1 x1
	N°2 x1
	N°4 x1

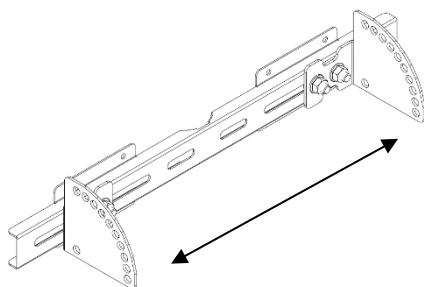
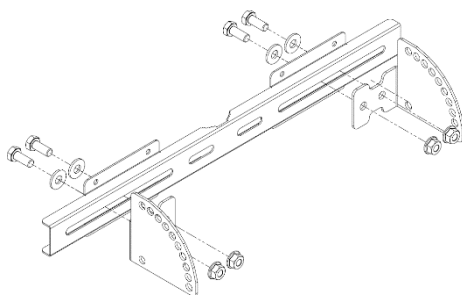

UNIFIX 50 - FIXATION MURALE/SOL/TOIT

- Fixez votre support avec 8 vis adaptées à votre surface (vis et chevilles non fournies).

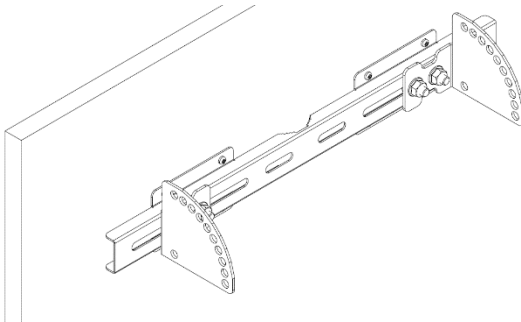
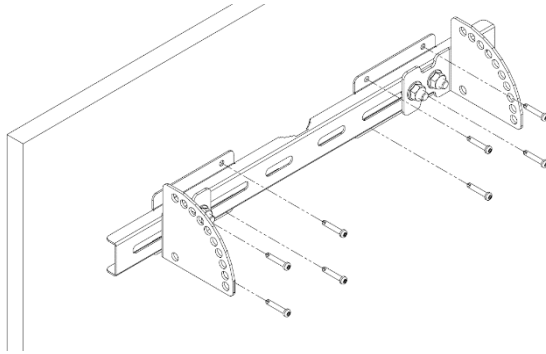
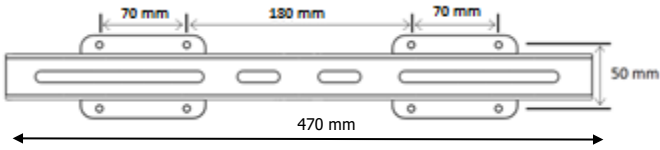

UNIFIX 50 - FIXATION MURALE/SOL/TOIT

- Unifix dispose d'un système d'inclinaison multi-positions. (10 positions). Définissez l'inclinaison souhaitée en fonction de l'orientation choisie.

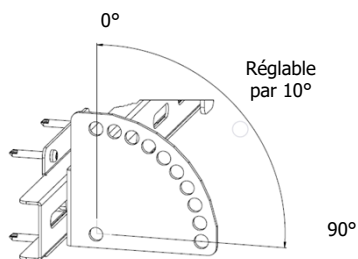

Performance électrique en fonction de l'inclinaison et de l'orientation panneau				
	0°	30°	60°	90°
Est	93%	90%	78%	55%
Sud-Est	93%	96%	88%	66%
Sud	93%	100%	91%	68%
Sud Ouest	93%	96%	88%	66%
Ouest	93%	90%	78%	55%

- Fixez votre panneau sur le système d'inclinaison

	M5x16 x4
	D5 x4
	M5 x4

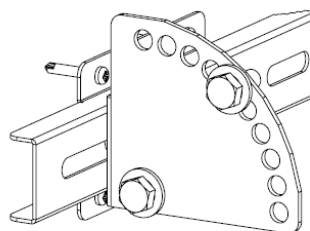
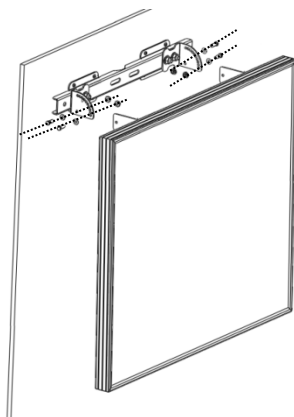



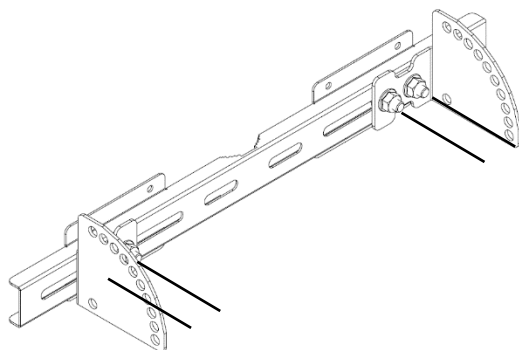

- Serrez maintenant les 4 écrous qui avaient été précédemment pré- vissés.



UNIFIX 50 FIXATION SUR MÂT ROND (DIAM. 40 À 60 MM)



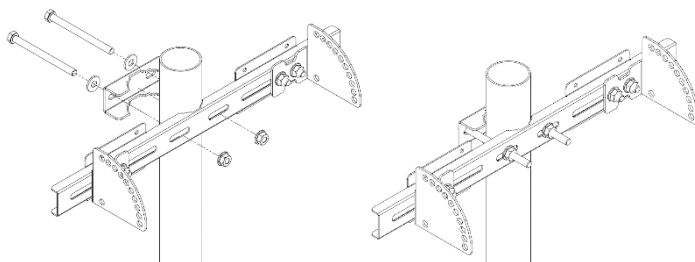

- Fixez le support au mât à l'aide de 2 brides et visserie M8 associée (pour fixation sur mât de signalisation, utiliser les brides correspondant au mât utilisé, brides non fournies).

	M8x100 x2
	D8 x2
	M8 x2
	n°13 x1

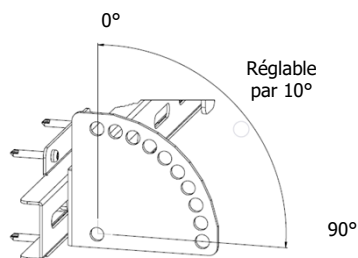

- Unifix dispose d'un système d'inclinaison multi-positions. (10 positions). Définissez l'inclinaison souhaitée en fonction de l'orientation choisie.



Performance électrique en fonction de l'inclinaison et de l'orientation panneau				
	0° 	30° 	60° 	90° 
Est	93%	90%	78%	55%
Sud-Est	93%	96%	88%	66%
Sud	93%	100%	91%	68%
Sud Ouest	93%	96%	88%	66%
Ouest	93%	90%	78%	55%

- Fixez votre panneau en fonction de l'inclinaison choisie et Serrez les 4 écrous qui avaient été précédemment pré- vissés.

	M5x16 x4
	D5 x4
	M5 x4

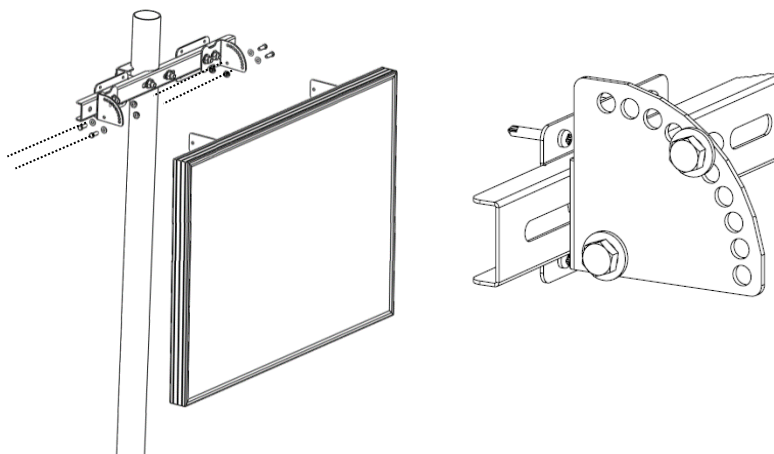

UNIFIX 50 FIXATION SUR MÂT ROND (DIAM. 40 À 60 MM)

- Serrez maintenant les 4 écrous qui avaient été précédemment pré-vissés.

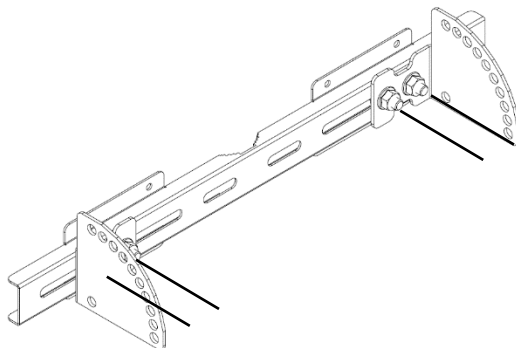
**GARANTIE**

La garantie couvre tout défaut ou vice de fabrication pendant 1 an, à compter de la date d'achat (pièces et main d'œuvre).

La garantie ne couvre pas :

- l'usure normale des pièces
- les erreurs de montage

En cas de défauts, retournez le produit à votre distributeur, en y joignant :

- un justificatif d'achat daté (ticket de sortie de caisse, facture...)
- une note explicative du défaut.

Attention : notre SAV n'accepte pas les retours en port dû.

Après la garantie, notre SAV assure les réparations après acceptation d'un devis.

Contact SAV :

Uniteck- 1 Avenue de Rome

Zae Via Europa - bâtiment Cassis

34350 Vendres -France

France mail: sav@uniteck.fr

Dear customer, thank you for purchasing one of our Uniteck products. Please read all the instructions carefully and thoroughly before using the product.

UNIFIX 50

Unifix brackets have been specially designed to fix your Unisun photovoltaic panels or equivalent (see part compatible panels):

- Unifix 50 for your Unisun 50.12M / 55.12BC panels

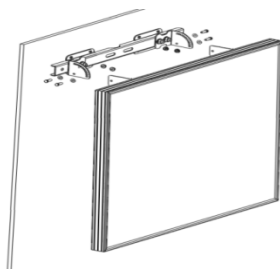

UNIFIX 50

Easy to install, they attach either:

- on a rigid horizontal or vertical surface (eg wall, concrete floor, wooden frame).
- on a round mast with a diameter of 40 to 60 mm (flange included)
- on a signaling posts using flanges with M8 screws

With their galvanized steel structure and corrosion-resistant stainless-steel screws, they are perfectly suited for outdoor use.

Equipped with a multi-position tilting system, Unifix brackets allow for an optimization of your panel's performance depending on the chosen orientation.

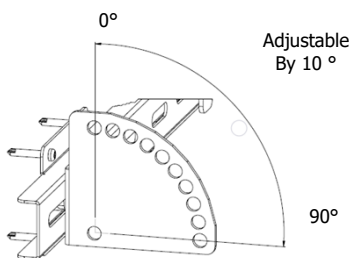

Electrical performance depending on tilt and panel orientation				
	0°	30°	60°	90°
East	93%	90%	78%	55%
South east	93%	96%	88%	66%
South	93%	100%	91%	68%
South west	93%	96%	88%	66%
West	93%	90%	78%	55%

To connect the the panel / regulator / battery, we recommend that you use the Uniconnect 1.6 ready-to-use kits that optimizes your electrical performance and simplifies installation (kit for connecting 1 panel)

UNIFIX 50

PANEL COMPATABILITY

With the design based on the use of Oblong drilling, Unifix can be used with different kind of panels on the market.

Unifix 50 is ment to fix 1 panel only, with the spacings and dimensions of panels as indicated below.

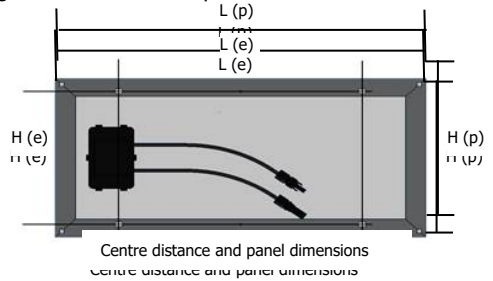

	Dim Support		Number of panels			Spacers for fastening of each panel (in mm)		Panel Dimension Max		Total weight Of panels (In Kg)
	L	H	x1	x 2	x 3	L (e)	H (e)	L (p)hh	H (p)	
Unifix 50	550	50	•			50 > 505	180 > 510	No max	550	6

SAFETY INSTRUCTIONS

- Take the appropriate mesures to prevent accidents during your mounting steps.
- If the bracket and the mounting tools are exposed to sunlight for a long period, there is a risk of getting burnt. Make sure to protect yourself accordingly.
- When finished, check and ensure that all of your brackets and panels are fixed properly.

UNIFIX 50

RECOMMENDATIONS

Mount Unifix brackets only on surfaces with sufficient bearing capacity. Consider the additional load with the panel:

Support	Panel
Unifix 50 = 2,6 kg	Unisun 50.12M / 55.12 BC = 4,1 kg / 3,8 kg

Fastening: to prevent large quantities of snow from accumulating behind the sensor, install appropriate barrier grids.

The position of the solar panel influences your electrical production. Choose the most optimal inclination and orientation to suit your environment. Avoid shaded areas or objects that are a source of shadow (eg tree)

Before attaching and connecting, please observe:

- the maximum distances between each element shown below.
- connecting order

Unifix wiring with Uniconnect 1.6 connection kit

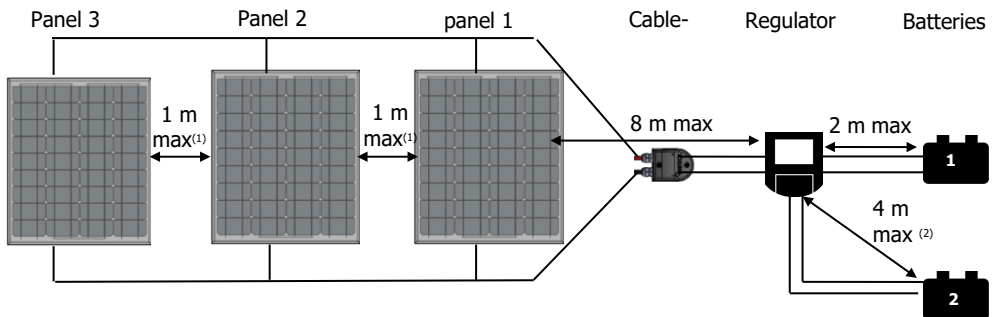

⁽¹⁾ Possibility to extend the distance between the panels by one additional meter, by adding a Unicable 612B and 612 R (cables not supplied with the Uniconnect 1.6 kit).

⁽²⁾ Battery connection kit, not included with Uniconnect 1.6 (optional).

Connecting Order

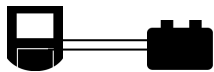

❶ connecting regulator → battery

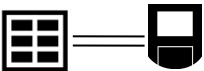

❷ connecting solar panel → regulator

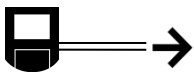







❸ connecting regulator → electrical devices

In case of disconnection please proceed in reverse order. For more information, refer to the operating manual of your photovoltaic charge regulator.

UNIFIX 50 - PREPARATION

LIST OF PIECES

						
M8x100 x2	M8X20 X8	M5x16 x4	D8 x 10	D5 x4	M8 x10	M5 x4

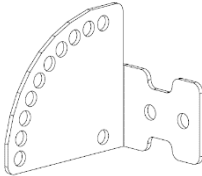
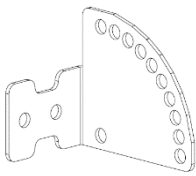
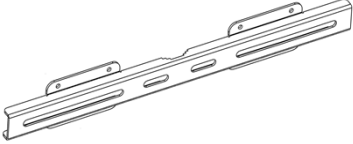
		
n°1 x1	n°2 x1	n°4 x1

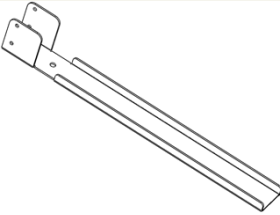
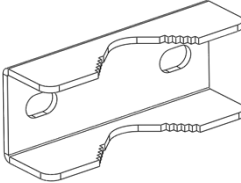
	
n°7 x2	n°13 x1



Recommended tightening torque

Vis	Couple
M5	5,10 Nm
M 6	8,80 Nm
M 8	21,50 Nm
M 10	44,00 Nm

Nb. Average friction coefficient $\mu = 0.20$ / Tightening at 50% of the elastic limit



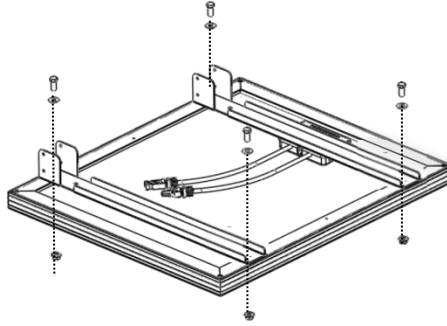

UNIFIX 50 - PREPARATION BEFORE MOUNTING

- Assemble the 2 brackets n° 7 on your Unisun photovoltaic panel. Pre-tighten the nuts. The final tightening will be done at the end of the assembly.

	M8x20 x4
	D8 x4
	M8 x4

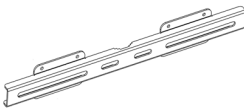

- Attach the n°1 and 2 pieces to the n°4. Place n°1 and 2 according to the size of your solar panel. Pre-tighten the nuts. The final tightening will be done at the end of the assembly.

	M8x20 x4
	D8 x4
	M8 x4
	N°1 x1
	N°2 x1
	N°4 x1

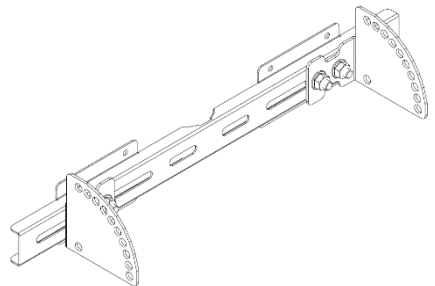
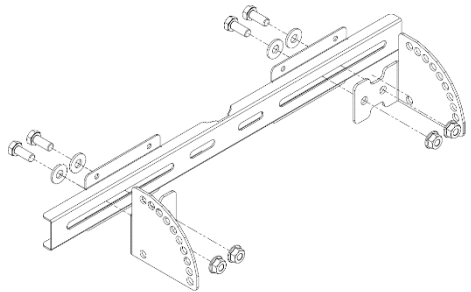

UNIFIX 50 - MOUNTING TO WALL / FLOOR/ ROOF

- Fix your bracket with 8 screws adapted to the supporting surface (screws and dowels not supplied).

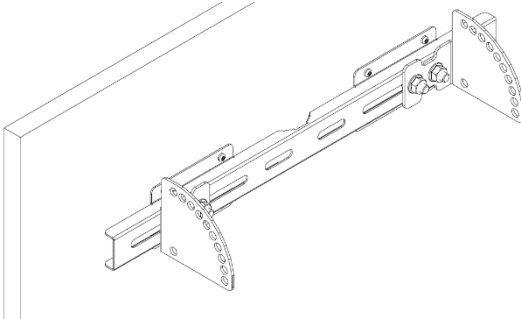
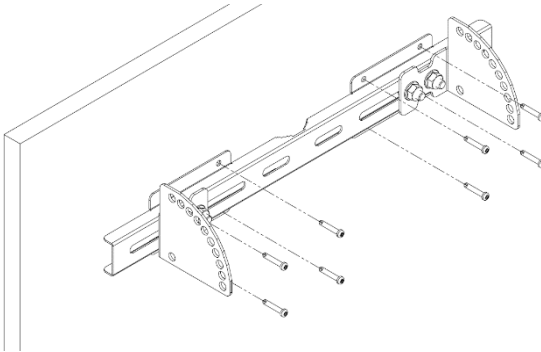
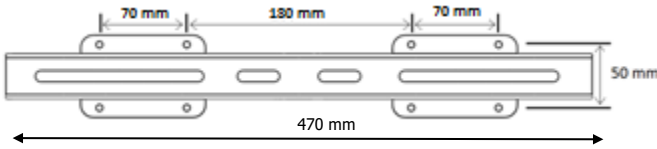

Unifix is equipped with a multi-position tilt system. (10 positions). Set the desired tilt depending on the desired orientation.

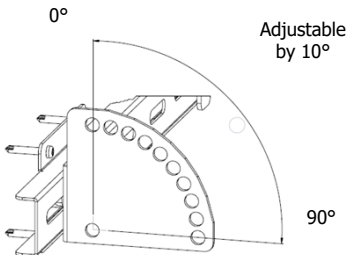

Electrical performance depending on tilt and panel orientation				
	0°	30°	60°	90°
East	93%	90%	78%	55%
South-East	93%	96%	88%	66%
South	93%	100%	91%	68%
South west	93%	96%	88%	66%
West	93%	90%	78%	55%

UNIFIX 50 - WALL MOUNTING / FLOOR / ROOF

- Attach the bracket to the mast with 2 flanges and associated M8 screws (for fixing to the signal mast, use the flanges corresponding to the mast used, flanges not included)

	M5x16 x4
	D5 x4
	M5 x4

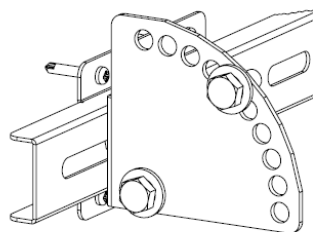
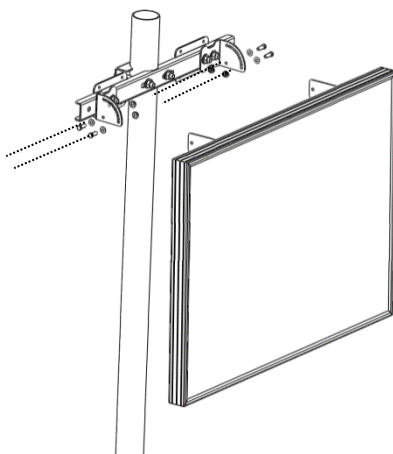



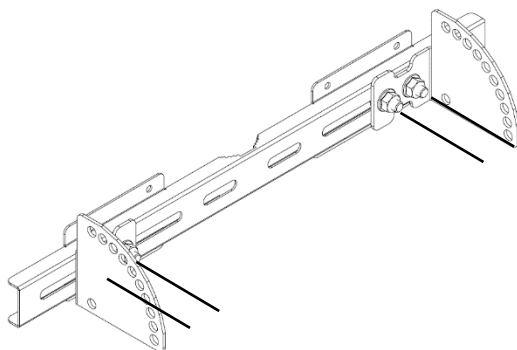

- Now tighten the 4 nuts that were previously pre-screwed.



UNIFIX 50 FIXING ON ROUND MAST (DIAM 40 TO 60 MM)

- Secure the bracket to the mast with its flange and screws



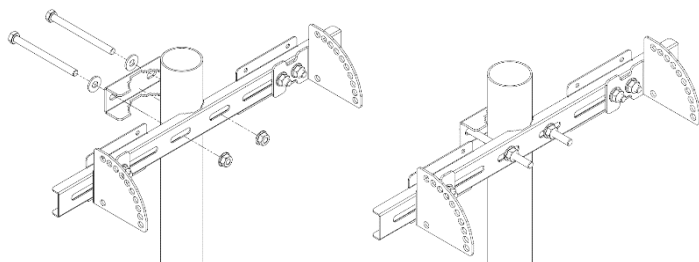

	M8x100 x2
	D8 x2
	M8 x2
	n°13 x1

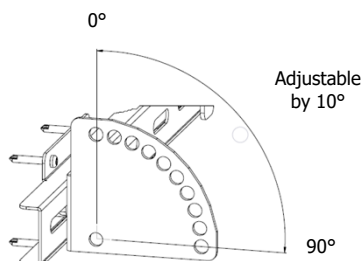

Unifix is equipped with a multi-position tilt system. (10 positions). Set the desired tilt depending on the desired orientation.



Electrical performance depending on tilt and panel orientation

	0° 	30° 	60° 	90° 
East	93%	90%	78%	55%
South-East	93%	96%	88%	66%
South	93%	100%	91%	68%
South west	93%	96%	88%	66%
West	93%	90%	78%	55%

- Fasten your panel according to the chosen inclination.

	M5x16 x4
	D5 x4
	M5 x4

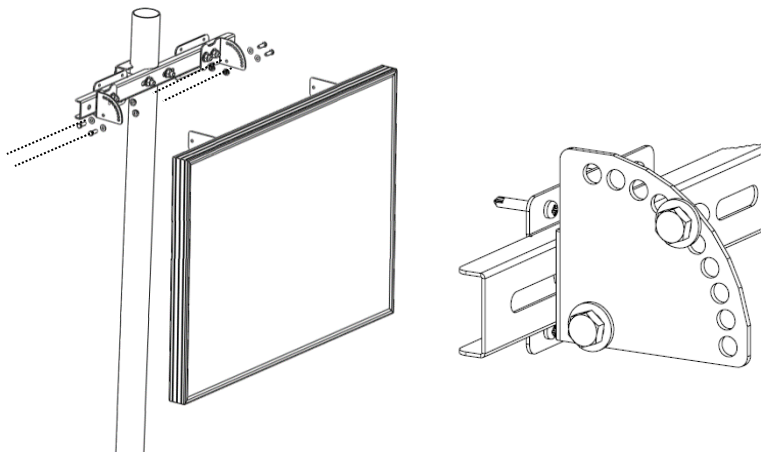

UNIFIX 50 FIXING ON ROUND MAST (DIAM 40 TO 60 MM)

- Now tighten the 4 nuts that were previously pre-screwed.

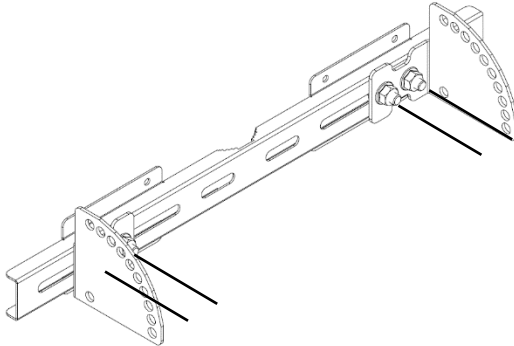

WARRANTY

The warranty covers any defect, manufacturing flaws for 1 year from the date of its purchase (Pieces and workforce).

Warranty does not cover:

- normal wear of parts
- faulty mounting of bracket

In case of failure, return the product to your distributor by attaching:

- the dated proof of purchase (receipt, bill...)
- explanatory note of the failure

Caution: Our after-sales service does not accept carriage forward/ collected returns.

After the warranty, our after-sales service ensures repairs after acceptance of a quotation.

After-sales service contact :

Uniteck- 1 Avenue de Rome

Zae Via Europa - bâtiment Cassis

34350 Vendres -France

E-mail : sav@uniteck.fr

UNIFIX 50

Estimado cliente, gracias por comprar nuestro producto Uniteck. Por favor lea con cuidado todas las instrucciones antes de usar el producto.

Los soportes Unifix están concebidos especialmente para fijar sus paneles Unisun o equivalentes: **(cf parte paneles compatibles)**:

- Unifix 50 para sus paneles Unisun 50M/55.12BC

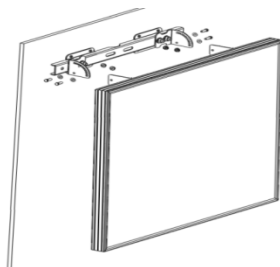

UNIFIX 50

Sencillos de instalar, se fijan o:

- sobre una superficie plana rígida con una orientación horizontal o vertical (ej.: pared, suelo hormigón, estructura de madera).
- sobre un mástil redondo de un diámetro desde 40 hasta 60 mm (brida provista)
- sobre mástiles de señalización utilizando bridas con tornillería M8

Gracias a su arquitectura en acero galvanizado y su tornillería en Inox resistente a la corrosión, están perfectamente adaptados para un uso exterior.

Dotados del sistema de inclinación multi posición, los soportes Unifix le permite optimizar sus rendimientos en función de la orientación elegida.

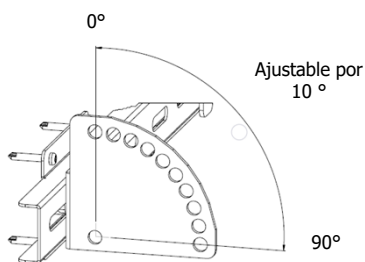

Rendimiento eléctrico en función de la inclinación y de la orientación panel				
	0°	30°	60°	90°
Este	93%	90%	78%	55%
Sur-Este	93%	96%	88%	66%
Sur	93%	100%	91%	68%
Sur Oeste	93%	96%	88%	66%
Oeste	93%	90%	78%	55%

Para realizar la conexión panel/regulador/batería, le recomendamos usar los kits listos para el uso Uniconnect que optimizan sus rendimientos eléctricos y simplifican el montaje:

- Uniconnect 1.6 = conexión 1 panel

UNIFIX 50

PANELES COMPATIBLES

Gracias a su diseño basado sobre el uso de la perforación Oblong, Unifix permite la fijación de diferentes paneles del mercado.

Unifix acepta 1 panel, con las entrevías y dimensiones paneles indicados más abajo.



Sistema de fijación oblongo

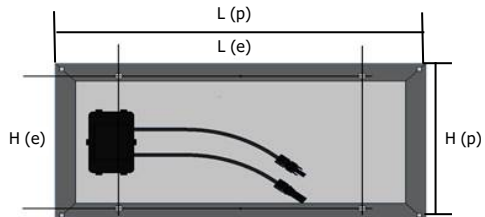

Distancia entre ejes y dimensiones del panel

	Dimensión soporte		Numero de paneles			Entrevías para la fijación de cada panel (en mm)		Dimensión panel maxi		Peso Total maxi paneles (en Kg)
	A	H	x1	x2	x3	A (e)	H (e)	A (p)hh	H (p)	
Unifix 20	550	50	•			80 > 505	100 > 300	no maxi	400	3

CONSIGNAS DE SEGURIDAD

- Tome las medidas apropiadas para prevenir los accidentes durante sus trabajos de montaje.
- Si el soporte y equipamiento de montaje están expuestos a los rayos del sol durante una larga duración, hay un riesgo de quemadura. Protéjase.
- En fin de los trabajos, verifique que sus soportes y paneles están bien fijados.

RECOMENDACIONES

Fije los soportes Unifix únicamente sobre superficies con una sustentación suficiente. Tenga en cuenta la carga adicional del panel:

Support	Panel
Unifix 20 = 2,6 kg	Unisun 50.12M / 55.12 BC =4,1 kg / 3,8 kg

Fijación: para evitar que importantes cantidades de nieve se acumulan detrás del sensor, primero instale una rejilla apropiada para parar la nieve.

La disposición de los sensores influye sus rendimientos eléctricos. Elija una inclinación y una orientación optima en función de su medio ambiente. Evite las zonas de sombra o que algunos objetos estén origen de sombra (ej.: árbol)

Antes toda fijación y conexión, por favor respete:

- las distancias máximas indicadas más abajo entre cada elemento
- el orden de conexión

Cableado Unifix + con kit de conexión Uniconnect

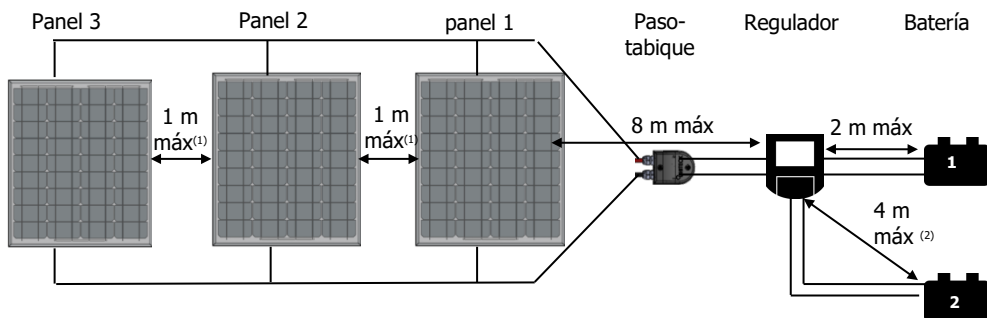

- (1) Posibilidad de alargar la distancia entre los paneles de un metro suplementario por añadir un Unicable 612B y 612 R (cables no provistos con los kits Uniconnect).
- (2) Kit conexión batería 2, no provisto con el kit Uniconnect (opción)

Orden de conexión

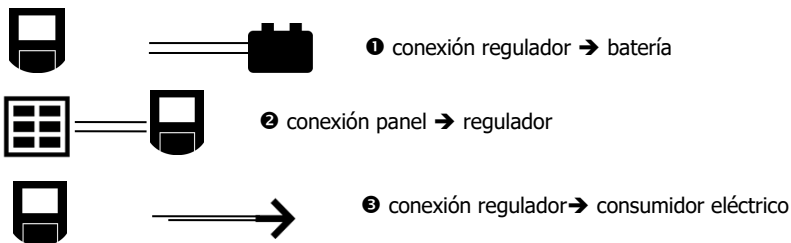







Para la desconexión, por favor siga el orden inverso. Para más informaciones, referirse al manual de instrucciones de su regulador de carga fotovoltaico.

UNIFIX 50 - Composición

Fácil de instalar, Unifix 50 puede ser fijo:

- sobre una superficie rígida horizontal o vertical (p. ej., pared, suelo de hormigón, marco de madera).
- en mástil redondo con un diámetro de 40 a 60 mm (brida suministrada)

LISTA DE LAS PIEZAS

						
M8x100 x2	M8x20 x8	M5x16 x4	D8 x 10	D5 x4	M8 x10	M5 x4

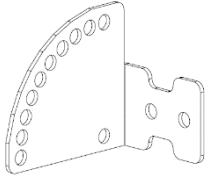
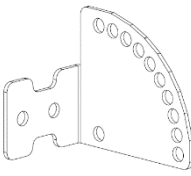
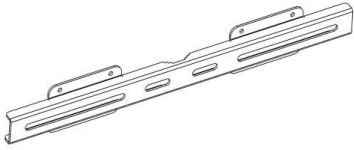
		
n°1 x1	n°2 x1	n°4 x1

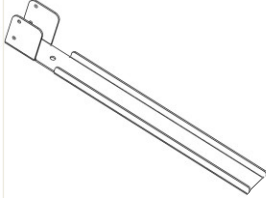
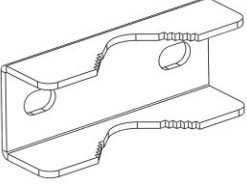
	
n°7 x2	n°13 x1



Par de apriete preconizada

Tornillo	Par
M5	5,10 Nm
M 6	8,80 Nm
M 8	21,50 Nm
M 10	44,00 Nm

Nb. Coeficiente de fricción medio $\mu=0,20$ / Presión al 50% de la limita elástica



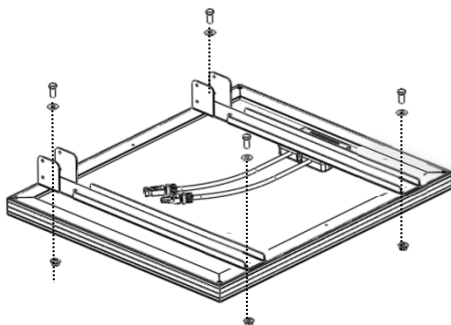

UNIFIX 50 - Preparación precedente al montaje

- Ensamble los soportes N°7 sobre su panel fotovoltaico Unisun.

	M8x20 x4
	D8 x4
	M8 x4

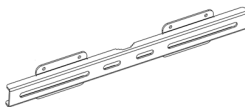

- Fije las piezas n°1 y 2 sobre la pieza n°4. Coloque las piezas 1 y 2 en función de la dimensión de su panel solar. Pre-apriete las tuercas. La presión definitiva estará realizada en fin de combinación

	M8x20 x4
	D8 x4
	M8 x4
	N°1 x1
	N°2 x1
	N°4 x1

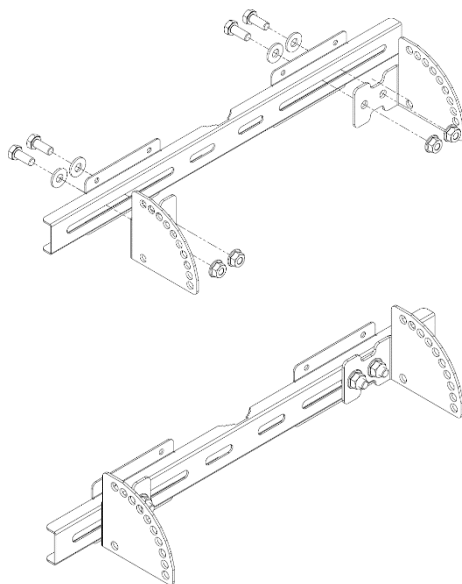

UNIFIX 50 - Fijación mural/suelo hormigón

- Fije su soporte con 8 tornillos adaptados a su superficie (tornillos y clavijas no provistos).

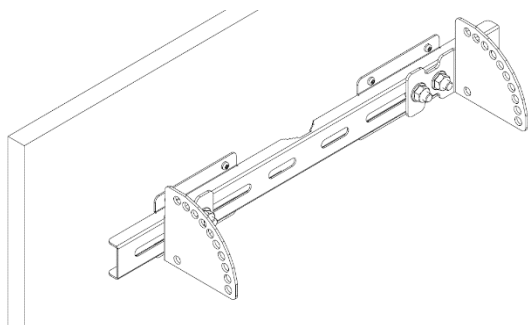
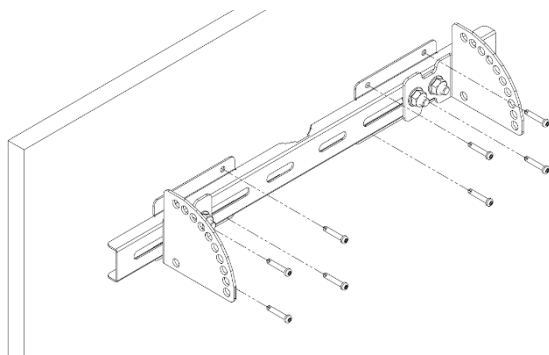
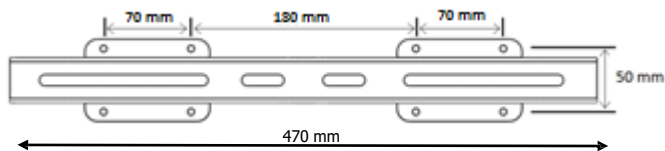

UNIFIX 50 - Fijación mural/suelo hormigón

- Unifix dispone de un sistema de inclinación multi-posición (10 posiciones). Defina la inclinación deseada en función de la orientación elegida.

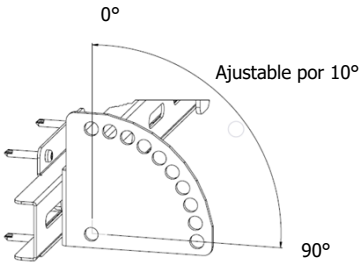

Rendimiento eléctrico en función de la inclinación y de la orientación panel				
	0°	30°	60°	90°
Este	93%	90%	78%	55%
Sur-Este	93%	96%	88%	66%
Sur	93%	100%	91%	68%
Sur Oeste	93%	96%	88%	66%
Oeste	93%	90%	78%	55%

- Fije su panel en función de la inclinación deseada.

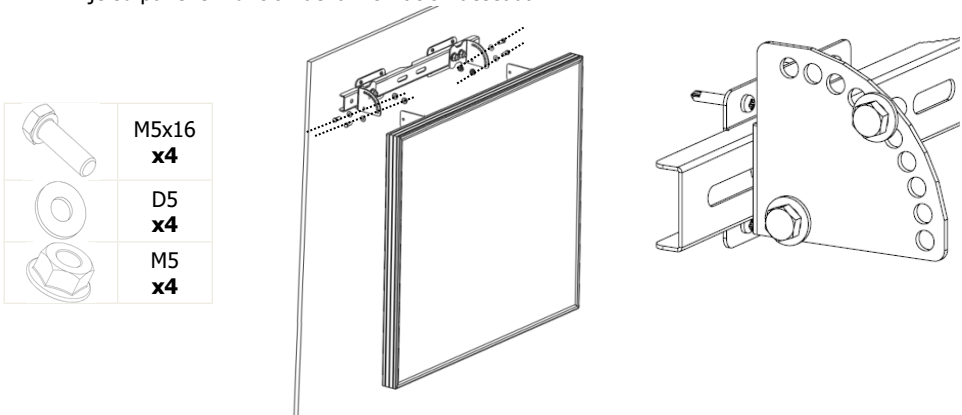



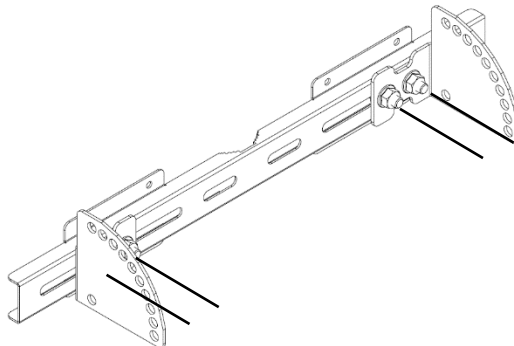

- Ahora apriete las 4 tuercas pre-Apretadas.



UNIFIX 50 - Fijación sobre mástil redondo (diam. 40 hasta 60 mm)



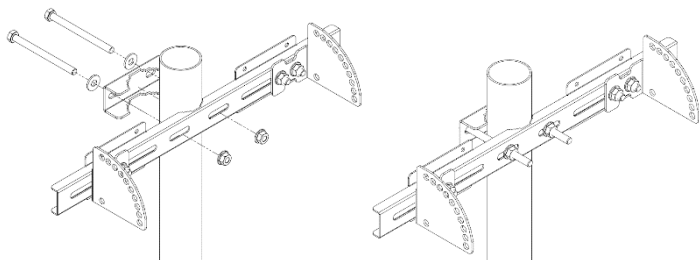

- Fije el soporte al mástil con su brida y su tornillería asociada

	M8x100 x2
	D8 x2
	M8 x2
	n°13 x1

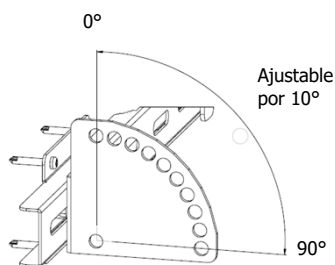

- Unifix dispone de un sistema de inclinación multi-posición (10 posiciones). Defina la inclinación deseada en función de la orientación elegida



Rendimiento eléctrico en función de la inclinación y de la orientación panel				
	0° 	30° 	60° 	90° 
Este	93%	90%	78%	55%
Sur-Este	93%	96%	88%	66%
Sur	93%	100%	91%	68%
Sur Oeste	93%	96%	88%	66%
Oeste	93%	90%	78%	55%

- Fije su panel en función de la inclinación elegida y apriete las 4 tuercas pre-Aprietadas.

	M5x16 x4
	D5 x4
	M5 x4

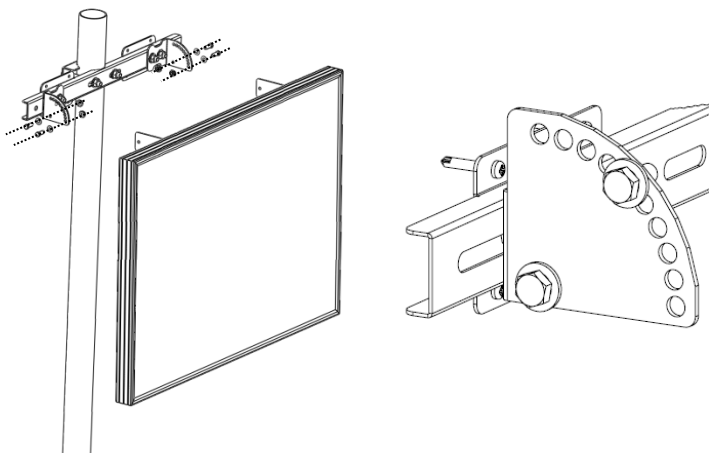

GARANTÍA

La garantía cubra todo defecto o todo vicio de fabricación durante 1 año, a partir de la fecha de compra (piezas y mano de obra)

La garantía no cubre :

-el desgaste normal de las piezas

En caso de avería, devuelva el aparato a su distribuidor, con :

- un justificado de compra con fecha (tiquete de caja central, factura, ...)

- una nota explicativa de la avería

Cuidado : nuestro Servicio Postventa no acepta devoluciones a portes debidos.

Después la garantía, nuestro Servicio Postventa asegura las reparaciones después aceptación de un presupuesto.

Contacto SAV :

Uniteck- 1 Avenue de Rome

Zae Via Europa - bâtiment Cassis

34350 Vendres -France

France mail: sav@uniteck.fr