



Mounting Brackets - Fixed UNIFIX SF



Adaptable on all signal masts



Corrosion resistant aluminum + A4 stainless steel screws



Easy to install



Can be fixed on any support



With flanges or U clamps (flanges and M8 or M10 screws in option)



POLE & MAST

FIXED BRACKETS FOR UNIVERSAL PANELS

Thanks to its universal fastening system, UNIFIX SF mounting bracket adapts to all signal masts.

Simply, slide your flanges with the M8 or M10 screws onto the rear rail and then tighten.

It has a fixed 35° panel inclination, optimum for an all year round use.



Can be fixed on the masthead or the middle of the mast (except UNIFIX 100SF, masthead only)



Can be fixed on any signal mast (flanges not included)



OPTION UNIFIX S or SF POST FLANGES STAINLESS STEEL FASTENERS (x2)

Diam 40-60 mm
Ref 2631

Diam 60-90 mm
Ref 2648

Diam 90-130 mm
Ref 2655

Diam 130-190 mm
Ref 2662

Diam 190-250 mm
Ref 4185

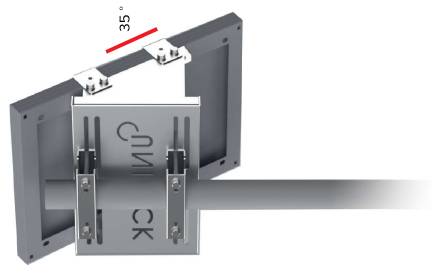

UNIFIX 55F

For Unisun 5,12 M

Portrait orientation

Masthead and middle of the mast

Mounting flanges in option

Ref 2693

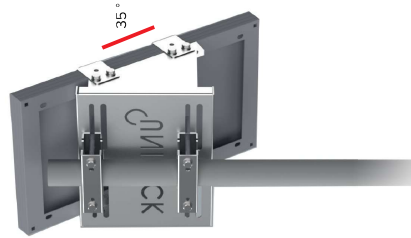

UNIFIX 20SF

For Unisun 10,12M/ 10,24M/ 20,12M/ 20,24M

Portrait orientation

Masthead and middle of the mast

Mounting flanges in option

Ref 1139

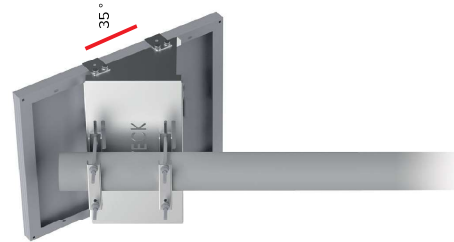

UNIFIX 50SF

For Unisun 30,12M/ 50,12M/ 50,24M/ 55,12BC

Portrait orientation

Masthead and middle of the mast

Mounting flanges in option

Ref 0064

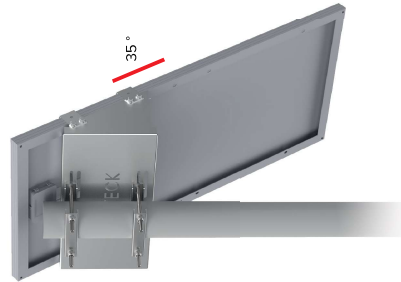

UNIFIX 100SF

For Unisun 80,12M/ 100,12M/ 100,24M/ 120,12BC

Portrait orientation

Masthead

Mounting flanges in option

Ref 1146



Mounting Brackets - Reclinable UNIFIX S

POLE & MAST



Adaptable on all signal masts

Corrosion resistant aluminum + A4 stainless steel screws

Easy to install

Reclinable from 30 to 60°

Can be fixed on any support

With flanges or U clamps (flanges and M8 or M10 screws in option)



Designed, made in France

RECLINABLE BRACKETS FOR UNIVERSAL PANELS

Thanks to their universal fastening system, UNIFIX S mounting bracket adapts to all signal masts. Simply, slide your flanges with the M8 or M10 screws onto the rear rail and then tighten.

UNIFIX S offers the possibility to choose the inclination. The tilting system enables you to optimize the electrical production according to the area and the period of use.

With its Easy Install system and their light aluminium structure, its mounting can easily be done alone, without extra assistance.



Light, innovative
Tilting multi-position system to optimize your electrical performances



Easy installation system
Its upper cap relieves the weight of the installation so that their mounting can easily be done alone, without extra assistance. This cap can be removed afterwards for a fixation on the middle of the mast. It is used on pole with a maximum of 130mm diameter. For UNIFIX 100S /150S /200S.



OPTION UNIFIX S or SF POST FLANGES STAINLESS STEEL FASTENERS (x2)

Diam 40-60 mm	Ref 2631
Diam 60-90 mm	Ref 2648
Diam 90-130 mm	Ref 2655
Diam 130-190 mm	Ref 2662
Diam 190-250 mm	Ref 4185

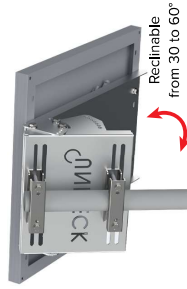

UNIFIX 50S

For Unisun 30.12M/ 50.12M/ 50.24M/ 55.12BC
Landscape orientation
Masthead or middle of the mast
Mounting flanges in option
Ref 0293

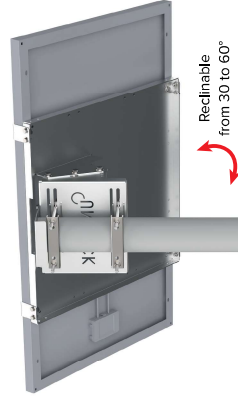

UNIFIX 150S

For Unisun 150.12M/ 150.24M/ 165.12BC/ 200.12BC
Landscape or portrait orientation
Masthead or middle of the mast
Mounting flanges in option
Ref 0866

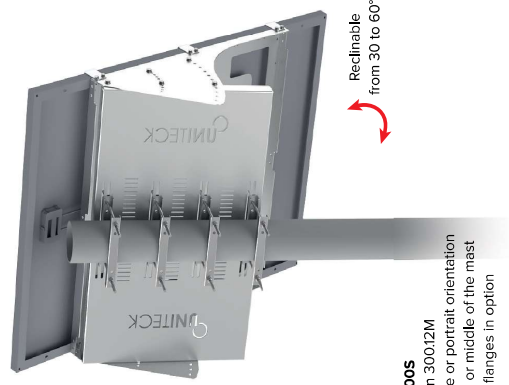

UNIFIX 300S

For Unisun 300.12M
Landscape or portrait orientation
Masthead or middle of the mast
Mounting flanges in option
Ref 2082

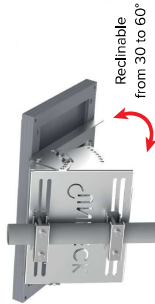

UNIFIX 20S

For Unisun 10.12M/ 10.24M/ 20.12M/ 20.24M
Landscape orientation
Masthead or middle of the mast
Mounting flanges in option
Ref 0286

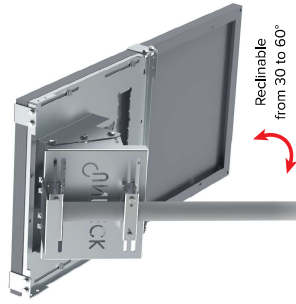

UNIFIX 100S

For Unisun 80.12M/ 100.12M/ 100.24M/ 120.12BC
Landscape or portrait orientation
Masthead or middle of the mast
Mounting flanges in option
Ref 0323

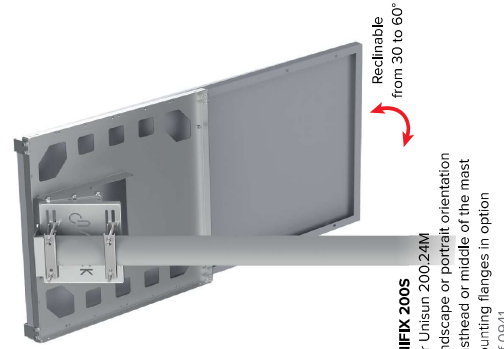

UNIFIX 200S

For Unisun 200.24M
Landscape or portrait orientation
Masthead or middle of the mast
Mounting flanges in option
Ref 0941